



INTERACTIVE HEALTH

Get-a-Way[®] CHAIR

RMS-14

Robotic Massage[®] Chair

USE & CARE MANUAL



INTERACTIVE HEALTH

www.vitalityweb.com

© Interactive Health[®], 2003

Patents Pending and intellectual property rights enforced by our brilliant team of aggressive attorneys around the world, including Taiwan. No medical claims are warranted or implied by the use of this product.

Important Safety Instructions

Read all instructions before using the RMS-14.

WARNING: Do not put hands or fingers near the massage mechanism or rollers while the RMS-14 is running. Touching the mechanism can result in injury from the rollers squeezing together.

DANGER: To reduce the risk of electrical shock

Always unplug massager from the electrical outlet immediately after using and before cleaning.

Do not reach for an appliance that has fallen into water. Unplug immediately.

WARNING: To reduce the risk of burns, fire, electric shock or injury to persons

An appliance should never be left unattended when plugged in.

Unplug from outlet when not in use, and before putting on or taking off parts.

Do not operate under blanket or pillow. Excessive heating can occur and cause fire, electric shock, or injury to persons.

Close supervision is necessary when this appliance is used by, on, or near children, invalids, or disabled persons.

Use this appliance only for its intended use as described in this manual. Do not use attachments not recommended by the manufacturer.

Never operate this appliance if it has a damaged cord or plug, if it is not working properly, if it has been dropped or damaged, or dropped into water. Return the appliance to a service center for examination and repair.

Always keep the power cord away from heated surfaces.

Never operate the appliance with the air openings blocked. Keep the air openings free of lint, hair, and the like.

Never drop or insert any object into any opening.

Do not use outdoors.

Do not operate where aerosol (spray) products are being used or where oxygen is being administered.

To disconnect, turn all controls to the OFF position, then remove plug from outlet.

Do not massage abdomen when pain is present or if you are pregnant.

Do not massage any area of the body that is swollen, inflamed or covered with skin eruptions. Do not use on unexplained calf pain.

Do not use massager when standing on a damp floor, or when any part of the body is in contact with plumbing or any similar ground.

Always connect massager to a properly grounded electrical outlet.

This unit is designed to operate on standard 120 Volt 60 Hz house current.

Do not use unit if noise above normal sound is heard.

The unit is designed for personal in-home use. Commercial use will void warranty.

SAVE THESE INSTRUCTIONS

For all grounded cord-connected products:

Grounding methods:

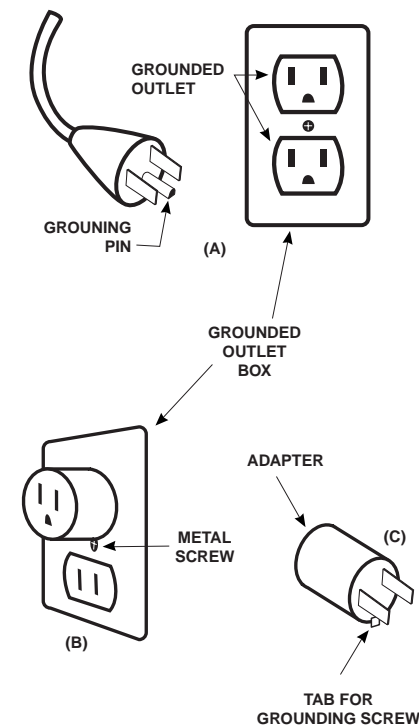

Grounding Instructions:

This product must be grounded. If it should malfunction or breakdown, grounding provides a path of least resistance for electrical current to reduce the risk of electric shock. This product is equipped with a cord having an equipment-grounding conductor and a grounding plug. The plug must be plugged into an appropriate outlet that is properly installed and grounded in accordance with all local codes and ordinances.

WARNING: Improper connection of the equipment-grounding conductor can result in a risk of electronic shock. Check with a qualified electrician or serviceman if you are in doubt as to whether this product is properly grounded. Do not modify the plug provided with the product – if it will not fit the outlet, have a proper outlet installed by a qualified electrician.

This product is for use on a normal 120-volt circuit and has a grounding plug that looks like the plug illustrated in sketch (A). A temporary adapter that looks like the adapter used in sketches (B) and (C) may be used to connect this plug to a 2-pole receptacle as shown in sketch (B), if a properly grounded plug is not available. The temporary adapter should be used only until a properly grounded outlet (sketch A) can be installed by a qualified electrician. The green colored rigid ear, tab or the like extending from the adapter must be connected to a permanent ground such as a properly grounded outlet box cover. Whenever the adapter is used, it must be held in place by a metal screw.

WARNING: Your chair is equipped with a thermal resetting protection device. This is an added safety feature to protect you and your massage chair from overheating. If the chair should suddenly stop and will not start, turn the main power switch, located on the back of the chair, off and do not operate the chair for at least 30 minutes. Failure to turn the chair off may result in the chair starting unexpectedly when the device cools.

Assembly Instructions

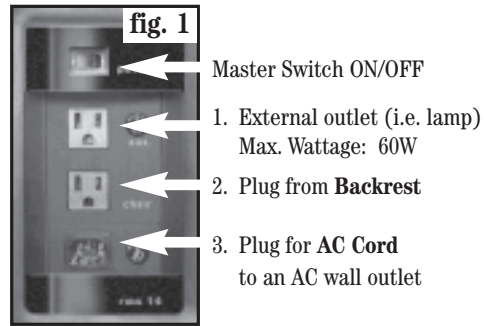

Fig 1. Seat Power Outlets

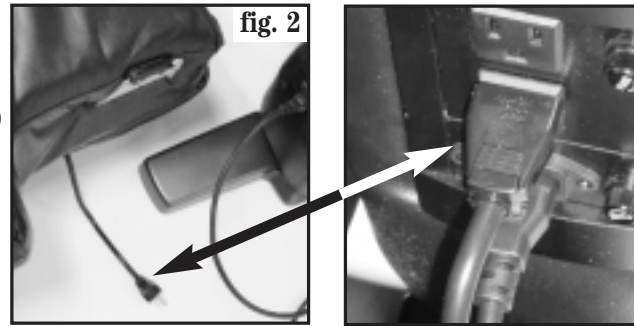

Fig 2. Plug cord from the **Backrest** into **Seat Power Outlet #2**. Plug **AC Cord** into **Seat Power Outlet #3**. **DO NOT PLUG AC CORD INTO WALL OUTLET** at this time.

Recline / Calf / Foot Massager Controller to Seat Assembly

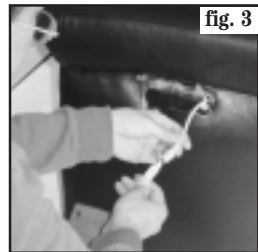
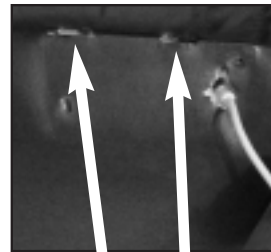

Fig 3. Connect the cord from inside the **Seat** to the **Recline / Calf / Foot Massage Controller**, then gently put the cord back in the **Seat**.



Top two Mount Holes on **Seat**

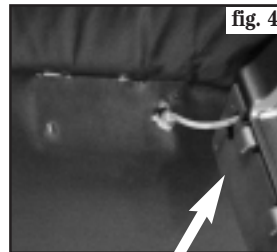

Fig 4. Secure the **Recline / Calf / Foot Massage Controller** on the side of the **Seat** by inserting the 2 clips on the top back of the **Recline / Calf / Foot Massage Controller** into the two mounting holes on the **Seat**.

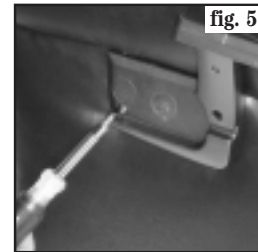

Fig 5. Screw the **Recline / Calf / Foot Massage Controller** to the **Seat**.

Ottoman connection to Seat via the Horseshoe Connector Assembly

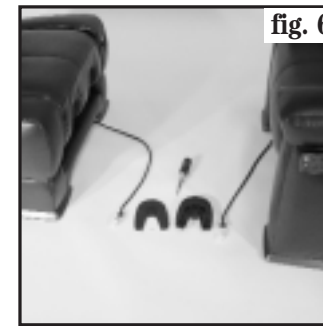
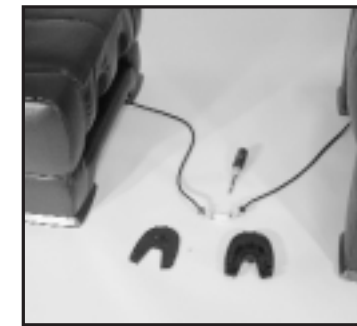

Fig 6. Place **Ottoman** and **Seat** as shown. **Top Horseshoe Connector** has **Interactive Health** logo. **Bottom Horseshoe Connector** is flat with screw opening.



Connect the cord from the **Ottoman** and the cord from the **Seat** at the ends with the two white connectors. When they lock together, you will hear a click.

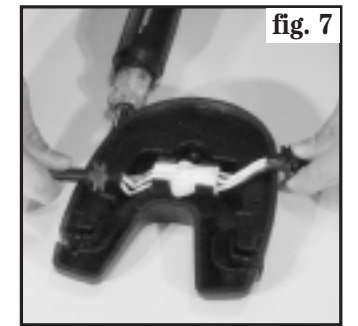

Fig 7. Place the connected cords into the **Top Horseshoe Shaped Connector** mounting.

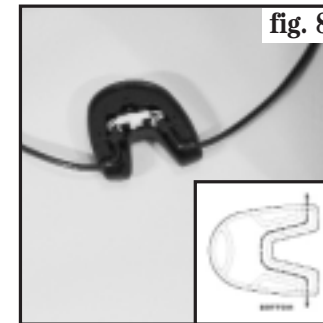
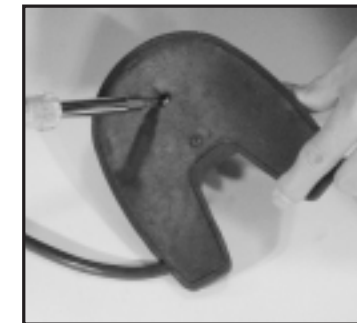

Fig 8. Run the power cords through the **Top Horseshoe Shaped Connector**.



Screw the top and bottom **Horseshoe Shaped Connector** mounting together.



How to activate Massage



Fig 9. Plug the **AC cord** into a **Grounded Wall Outlet**. Turn the **Master Switch ON**.

How to Use the Calf & Foot Massage Mechanism

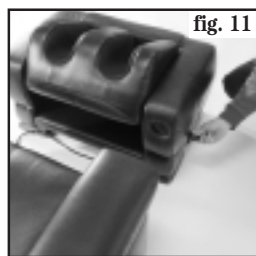

Fig 11. **Ottoman Lever Handle.** Push down this handle to slide the Calf & Foot Massage Mechanism **towards you / Seat**. Pull the handle up to slide the Calf & Foot Massage Mechanism **away from you / Seat**.



Fig 12. **Massage Release Lever.** Pull out this release lever to rotate the Calf & Foot Massage Mechanism. CAUTION: The Massage Mechanism does not rotate 360°.

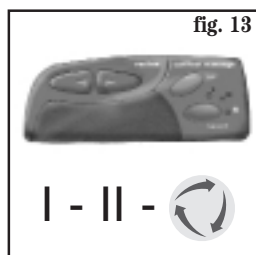
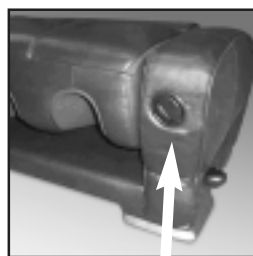

Fig 13. Press ON / OFF to activate Calf & Foot Massage. Press SPEED to adjust from LOW I, to HIGH II, to Program . Press ON / OFF to stop the Calf & Foot Massage.



Foot Massage Position



Calf Massage Position

Rotate the Calf & Foot Massage Mechanism to illustrated positions until you hear a click to set it in a locked position. (see Fig. 13)

How to use your Power Recline

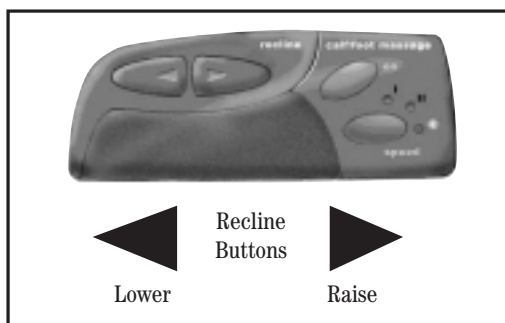

Lower / Recline the **backrest** of the chair by pressing the **Recline Button** on the **Calf & Foot Massage Controller**. Raise / Incline the **backrest** of the chair by pressing the **Recline Button** on the **Calf & Foot Massage Controller**. A slight delay will happen when you go from Recline to Incline function.



Place the remote control on the magnetic holder when it is not being used.

Description of RMS-14 Remote Control

1. SHOULDER POSITION

Adjust the length of the massage roller stroke, based on your body size.

2. ON / OFF

To activate the massage chair or to turn off.

3. MASSAGE

After turning the chair on, press the massage button to activate one of the functions below (knead, tapping, rolling, partial, or knead & tap).

4. KNEAD

To activate the kneading function.

5. TAPPING

To activate the tapping function.

6. ROLLING

To activate the rolling function.

7. PARTIAL

To activate a partial massage on a specific section of your back.

8. KNEAD & TAP

To activate both kneading and tapping functions combined.

9. SPEED

To adjust the speed of the massage.

10. WIDTH

To adjust the width of the massage.

11. PROGRAMS

After turning the chair on, press the programs button to activate one of the desired courses from A, B or C.

12. UPPER COURSE (A)

A pre-programmed course on the upper section of your back.

13. WHOLE COURSE (B)

A pre-programmed course on your whole back.

14. LOWER COURSE (C)

A pre-programmed course on the lower section of your back.

15. ADJUST UP

To adjust the massage roller up during a stationary massage function.

16. ADJUST DOWN

To adjust the massage roller down during a stationary massage function.











RMS-14 Massage Programs



Check that the POWER switch is in the OFF position before commencing your massage.

Start the massage by performing the following 1, 2, 3 operation.

1. **PRESS THE  START SWITCH.**
The  button and the  Programs button will light up in GREEN.
2. **PRESS THE  PROGRAMS BUTTON.**
The  Programs button will light up in RED.
The Course buttons   and  will light up in GREEN.
3. **SELECT THE PROGRAMS COURSE.**

Once selected, the Course button will light up in RED, and the massage will begin. If you wish, you may press the other Course buttons during the massage, and the Course will change to the newly selected one.

DESCRIPTION OF BUTTON LIGHTS AND FUNCTIONS

- ON (GREEN)** These buttons are available to be selected while they are lit in green. Choose from one of the green buttons to select the desired function.
- ON (RED)** Indicates that the button lit in red is the currently operating function.
- OFF (NONE)** These buttons are not lit and their functions are not currently available.

4. **ADJUST THE HEIGHT OF THE MASSAGE ROLLER.**

While in motion, the massage roller will come to the top of its cycle before continuing down. Press the  button to adjust the massage roller to an appropriate height. Each time the button is pressed, the massage roller position changes, and the corresponding light will illuminate.

The interval between each shoulder position is 2 3/4".

If the massage roller cannot be adjusted to the correct position by using the Shoulder Position button, use the Shoulder Position button to bring the roller as close as possible to the correct position, then shift your body's seating position until the uppermost travel of the massage roller is in the correct position.

TO STOP THE MESSAGE

Press the  START switch. The POWER light on the remote control will flicker, and the massage roller will move to the uppermost position, and the massage will stop.

TO STOP THE MESSAGE TEMPORARILY

Press the currently selected Course button, and the massage will stop at its current position. Press the button once again to resume the massage.

Caution:

If any excessive force is applied to the massaging roller during use, it may automatically stop for safety reasons. If this occurs, all MANUAL buttons of the remote control will light in RED. To resume the massage, turn off the POWER switch temporarily and turn it on again after 3 seconds.

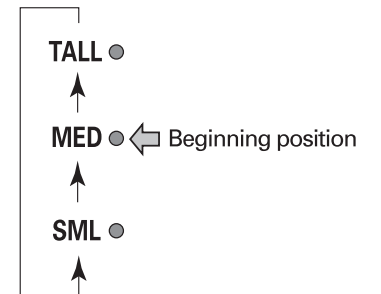
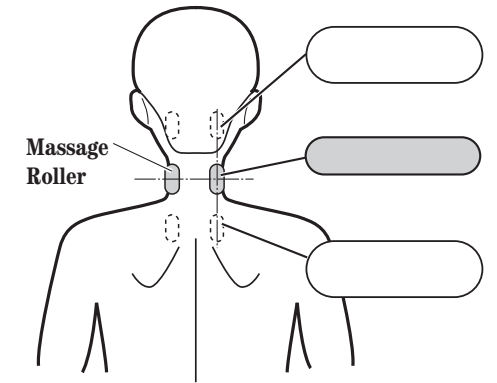

RMS-14 Massage Programs

UPPER

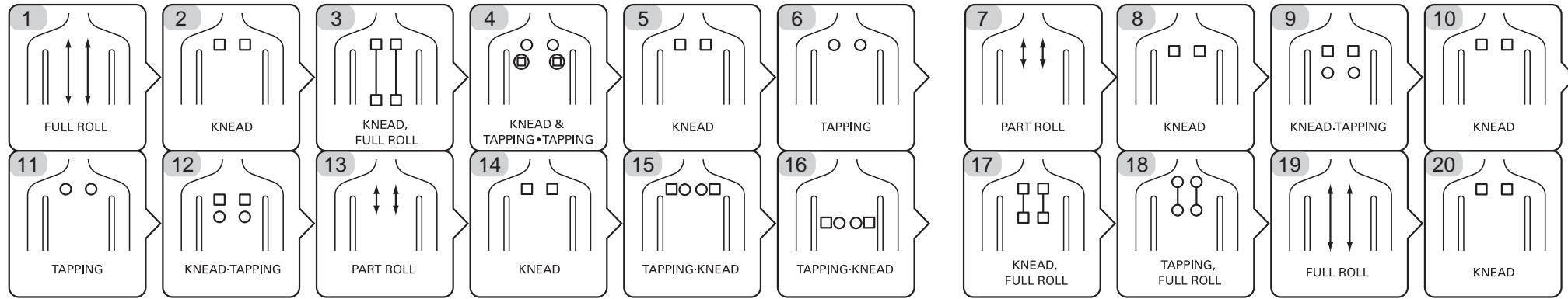

WHOLE

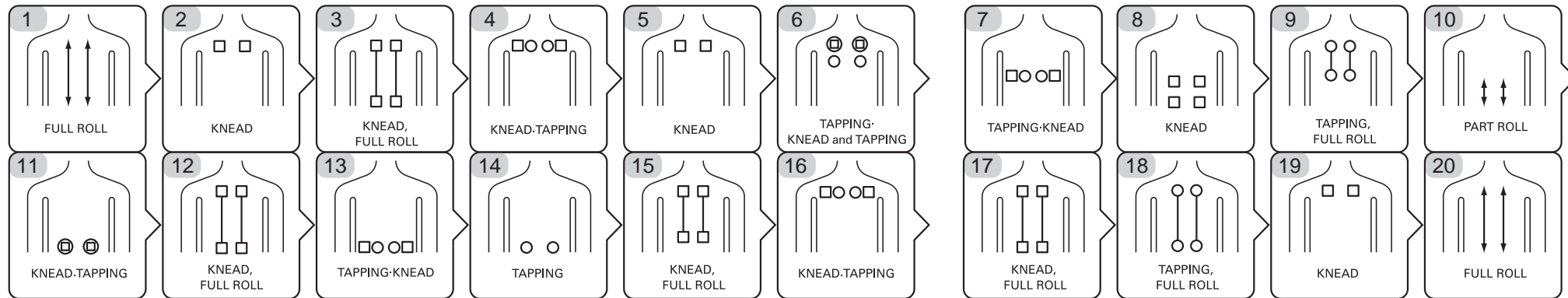

LOWER

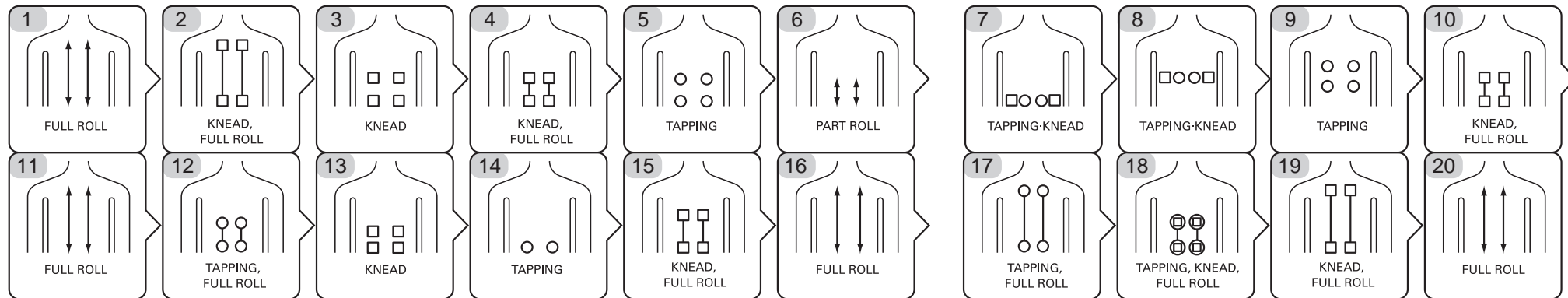











Operation indication	Operation
	KNEAD & TAPPING
	KNEAD
	TAPPING
	TAPPING, KNEAD, FULL ROLL
	KNEAD, FULL ROLL
	TAPPING, FULL ROLL
	FULL ROLL
	PART ROLL



Check that the POWER switch is in the OFF position before commencing your massage.

Start the massage by performing the following 1, 2, 3 operation.

1. **PRESS THE  START SWITCH.**
The  button and the  Programs button will light up in **GREEN**.
2. **PRESS THE  BUTTON.**
The  Programs button will light up in **RED**.
The manual massage buttons  
  and  will light up in **GREEN**.
3. **SELECT THE DESIRED MESSAGE BUTTON.**
Once selected, the selected message button will light up in **RED**, and the massage will begin. If you wish, you may press the other Massage buttons during the massage, and the massage will change to the newly selected one.

DESCRIPTION OF BUTTON LIGHTS AND FUNCTIONS

- ON (GREEN)** These buttons are available to be selected while they are lit in green. Choose from one of the green buttons to select the desired function.
- ON (RED)** Indicates that the button lit in red is the currently operating function.
- OFF (NONE)** These buttons are not lit and their functions are not currently available.

4. ADJUST THE MESSAGE ROLLER.



SPEED



Press the  SPEED ADJUST button. The speed of the massage will change each time the button is pressed and the corresponding speed indicator light will illuminate.

WIDTH

Press the  WIDTH ADJUST button. The width of the massage will change each time the button is pressed and the corresponding width indicator light will illuminate.

UP/DOWN ADJUSTMENTS

Press the  UP, or  DOWN buttons to move the massage roller to the desired location. If held down, the massage roller will move up or down continuously in the corresponding direction.















The massage roller can be fixed at the lowest position, which may be desired when wanting to massage the lower back area exclusively. Continue pressing the  DOWN button until the massage roller reaches its lowermost position. By holding the DOWN button for another 3 seconds, the roller position will be fixed there. Press  to cancel.

TO STOP THE MESSAGE

Press the  START switch. The POWER light on the remote control will blink, and the massage roller will move to the uppermost position, and the massage will stop.

TO STOP THE MESSAGE TEMPORARILY

Press the currently selected Massage button, and the massage will stop at its current position. Press the button once again to resume the massage.

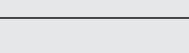
Type of massage	Kneading operation	 Height adjustment	 SPEED Speed adjustment	 WIDTH Width adjustment	 Up/Down adjustment
	Kneading operation.	—	○	—	○
	Kneading by tapping operation.	—	○	○	○
	Kneading of upper half of body by backbone stretching.	○	—	○	—
	Kneading by stretching operation of massaging ball within specific range.	—	—	○	○
	Knead at the same time performing the tapping and kneading actions.	—	○	—	○
	Kneading by backbone stretching of upper half of body, while executing kneading operation.	○	○	—	—
	Kneading by stretching operation, while executing partial stretching operation.	—	○	—	○
	Kneading by backbone stretching of upper half of body, while executing tapping operation.	○	○	○	—
	Kneading by partial stretching operation, while executing partial tapping operation.	—	○	○	○
	Kneading backbone stretching, while executing tapping and kneading operation.	○	○	—	—
	Kneading by partial stretching, while executing tapping and kneading operation.	—	○	—	○

○ Adjustable — Unadjustable

To keep your product working and looking its best, please follow these simple care guidelines.

General Maintenance

1. Be sure to disconnect the power cord from the electrical outlet before cleaning.
2. Do not use benzene, thinner or any other solvents on your massage chair.
3. Remove dust on the backrest or armrest with a vacuum.
4. If the backrest or armrest become soiled, wipe with a damp cloth, then a dry cloth.
5. Common Leather cleaners may be used for tough stains.
Please follow all manufacturer's instructions on cleaner packaging and pre-test any cleaner on a small inconspicuous area prior to use.
6. When cleaning the controller or around the power switch, use a dry cloth only. **Never use a damp cloth to clean the controller or power switch.**
7. It is suggested that you cover the chair when not in use for a long period of time.
8. The mechanics of this product are specially designed and constructed to be maintenance free. No periodic lubrication or servicing is required.
9. Foreign objects should not be inserted between the massage nodes or the unit housing.
10. When not in use for a long period of time, we recommend that the power cord be coiled and that the unit be placed in an environment free of dust and moisture.
11. Do not store near heat or open flame. Do not leave this product exposed to direct sunlight for long periods of time. This may cause fading or damage.

